



ELECTRIC DRIVES
FOR EVERY DEMAND

VEMPars Motors Co. Presentation

www.vempars.com

www.vem-group.com



VEMPars motor Co.

Introduction

Iran Far East Co.

- Since approximate 50 years ago
- Commercial activities about German industrial Equipment such as VEM electric Machine
- Tehran commercial office

VEMPars Motor Co.

- After Islamic revolution
- Shiraz Especial Economic Zone
- Mutual investment of Iran & Germany to establish VEM factory in Iran
- production, machinery, Assembling, test, marketing and sales, after sales service, repairing and rewinding



VEMPars motor Co.

Introduction

The Iranian Minister of Industry and Mining, Mr. Jahangiri greets the VEM delegation in Teheran- 6th April 2004





VEM Pars motor Co.

Introduction

Signing the contract in Shiraz – 7th April 2004





ELECTRIC DRIVES
FOR EVERY DEMAND

VEMPars Motors Co. Shiraz Factory

www.vempars.com

www.vem-group.com



VEMPars motor Co.

Factory Units

- Machinery and assembling
- Painting & packing
- Test facility for electric motors
- Winding & repairing
- Sales & after sales services

Machining Unit



VEMPars motor Co.



Machining Unit



VEMPars motor Co.



Assembly Unit



VEM Pars motor Co.



Laboratory and Test facilities

VEMPars Co. has a laboratory to test the electric motors in different ways:

- No- load test – up to 560 kW
- Full- load test – up to 75 kW
- Locked rotor test – up to 75 kW

We do according to the Iran standard organization.





جمهوری اسلامی ایران
سازمان ملی استاندارد ایران
اداره کل استاندارد استان فارس

شماره گواهینامه: ۲۵۳۳۳۳۳
تاریخ تمدید: ۱۳۹۴
برای تعداد: -
برای مدت: ۱۱

شماره ۱۳۱

گواهینامه تایید صلاحیت آزمایشگاه همکار

به استناد روش اجرایی «تایید صلاحیت و نظارت بر عملکرد آزمایشگاه های آزمون و کالیبراسیون»،
به شماره مدرک ۱۳۱۳۳-۸ از آزمایشگاه شرکت الکترومولیر منطقه ویژه شیراز برای انجام آزمون های مشروحه زیر
تایید میگردد.

شماره استاندارد (مربوط به نوع تایید سازمان)	نوع آزمون	نوع محصول
ISIRI ۳۷۷۲-۱	مشخصات اسمی و عملکردی	ماشین الکتریکی دوار (الکترومولیر)
ISIRI ۷۹۶۶	معیارها و مشخصات فنی مصرف انرژی و دستورالعمل برجست انرژی	مولدهای الکتریکی القایی سه فاز

عزتلی و همکاران
مدیر کل





تذکره:
۱- مدت اعتبار این گواهینامه از تاریخ صدور تمدید یک سال می باشد.
۲- داشتن این تاییدیه به رافع مسئولیت های حقوقی و جزایی ذاینده آن نمی باشد.
۳- رعایت تعهدنامه همکاری با سازمان ملی استاندارد ایران الزامی است.
۴ در صورتی که آزمون هر زمینه تعیین ماهیت باشد و استاندارد مشخص برای آن وجود نداشته باشد از شرایط فلهایی مربوطه
از جمله حوزه های تعریف شده استاندارد یا اصول کتاب مقررات صادرات و واردات استفاده می شود.

آدرس آزمایشگاه: بلوار خلیج فارس صنعتزاده به پستی راه قاسم - جاده اختصاصی نیروگاه سیکل ترکیبی - منطقه ویژه اقتصادی شیراز
تلفن و فاکس: ۳۷۱۷۵۱۰۴ و ۳۷۱۷۵۱۵۷

Laboratory and Test facilities

VEMPars Co. MV test bench

- up to 2000KW No. load test
- voltages: up to 6900V



VEMPars motor Co.





ELECTRIC DRIVES
FOR EVERY DEMAND

VEMParS Motors Co. Domestic Production

www.vempars.com

www.vem-group.com



VEMPars motor Co.

Domestic Electric motor Manufacturer

VEMPars Co. is known as a interior electric motor manufacturer in Iran by all of the production permissions and certificates of Iranian organizations.





VEMPars motor Co.

Domestic Electric motor Manufacturer

We are developing the production space in Shiraz, to transfer the manufacturing technology from the main holdings to Shiraz.

شماره پروانه : ۹۵۶۴۲۵
 تاریخ پروانه : ۱۳۸۶/۰۷/۰۴
 شناسه کسب و کار : ۶۰۹۶۱۶۰۹۲۳۷۵

جمهوری اسلامی ایران
 وزارت صنعت، معدن و تجارت
 سازمان منطقه آزاد تجاری-صنعتی و ویژه اقتصادی
پروانه بهره‌برداری
 (مجوز بهره‌برداری صنعتی)

این پروانه به استناد قانون چگونگی اداره مناطق آزاد تجاری-صنعتی و قانون تشکیل و اداره مناطق ویژه اقتصادی صادر شده است.
 الف- مشخصات واحد تولیدی:
 الکترو موتور منطقه ویژه شیراز (شرکت سهامی خاص) با شماره ثبت ۱۵۰۳۰ مورخ ۱۳۸۲/۱۲/۲۴ شناسه ملی ۱۰۵۳۰۲۷۳۱۹۷ ثبت شده در به آدرس محل فعالیت منطقه ویژه اقتصادی شیراز، بلوار تجارت شرقی، کارخانه الکتروموتور منطقه ویژه شیراز.
 با توجه به راه اندازی و دستیابی آن واحد به انجام عملیات تولید انبوه، این پروانه جهت تولید محصولات زیر به منظور استفاده از مزایای قانونی آن اعطا می‌گردد. (برای سه شیفت)

ردیف	محصولات اصلی	ظرفیت سالیانه	واحد	کد شناسایی کالا
۱	انواع پالت چوبی	۲۰	تن	۲۰۲۳۴۱۲۳۰۳
۲	موتور برقی AC سه فاز آسکرون	۵,۰۰۰	مستگاه	۳۱۱۰۵۱۲۴۳۴
۳	موتور برقی AC سه فاز آسکرون ضد انفجار	۷,۰۰۰	مستگاه	۳۱۱۰۵۱۲۴۳۴

نام شرکت: منطقه ویژه اقتصادی شیراز
 نام مدیرعامل: [محل امضا]

توجه: این پروانه تاوجه به توضیحات پشت مشخصه‌ها دارای اعتبار است.



VEMPars motor Co.

Domestic Electric motor Manufacturer

شماره: ۱۰۰۰۰۰۰۰
تاریخ: ۱۳۹۷/۰۹/۲۹
پست: ۰۰۰۰۰۰

جمهوری اسلامی ایران
وزارت صنعت، معدن و تجارت
سازمان صنعت معدن و تجارت استان فارس

با سلام،

احتراماً، با عنایت به لزوم حمایت از صنایع و تولیدات داخلی، منطقه ویژه اقتصادی شیراز به عنوان یکی از مراکز اجتماع جمعی از صنعتگران و تولیدکنندگان داخلی کشور به حضورتان معرفی می گردد. صنایع و مراکز حاضر در این مجموعه با بهره گیری از معافیت های ویژه و مشوق های اختصاصی مناطق ویژه تاکنون توانسته اند با تولیدات متنوع خود بخش قابل توجهی از نیازهای کشور را با تولیدات داخلی تأمین نمایند. یکی از موفق ترین واحدهای صنعتی در این منطقه کارخانه الکتروموتور منطقه ویژه شیراز(وم پارس) بوده که نزدیک به ۱۲ سال فعالیت خود، توانسته است نیازهای صنایع مختلف کشور به عنوان الکتروموتورهای صنعتی ۳ فاز را تأمین نموده و با انتقال تکنولوژی و دانش فنی از شرکت VEM آلمان به داخل کشور، نقش به سزایی در اشتغال زایی و تأمین نیازهای داخلی داشته است. لذا خواهشمند است به منظور حمایت از صنایع داخلی، دستور فرمائید تا از تفریفات ها و پتانسیل های این شرکت در پروژه های جاری آن مجموعه محترم اقدام مقتضی مبذول گردد. ۱۳۹۷/۰۹/۲۹

نمایندگان شهرستان شیراز در مجلس شورای اسلامی

فرج اله رحیمی
علی اکبری
مسعود رضایی
ایرج پارسا

شماره: ۱۰۰۰۰۰۰۰
تاریخ: ۱۳۹۷/۰۹/۲۹

جمهوری اسلامی ایران
وزارت صنعت، معدن و تجارت
سازمان صنعت معدن و تجارت استان فارس

سلام تلنگر

با احترام، شرکت الکترو موتور منطقه ویژه شیراز (VEM Pars) معرفی میگردد. مزید استحضار است این شرکت در حال حاضر یکی از واحدهای بسیار فعال می باشد که با در اختیار داشتن پتانسیل های فیزی و نیروی انسانی متخصص فنی و دانشگاهی تحت لیسانس شرکت VEM آلمان از سال ۱۳۸۶ مشغول به کار بوده و خوشبختانه بر اساس سیاست توسعه ای سازی تکنولوژی توانسته نسبت به انتقال دانش فنی ساخت قطعات انواع الکترو موتور را تولید نماید. همچنین این شرکت دارای آزمایشگاه بسیار مجهز تست الکترو موتور و مورد تأیید اداره استاندارد و تجهیزات صنعتی ایران می باشد که طی حکم شماره ۴۸/۲۷۵۲ شناخته شده است علی اجمال با عنایت به شماره فوق الإشارة خواهشمند است بمنظور حمایت از صنایع داخلی دستور فرمائید از تفریفات های فنی و تولیدی این شرکت در پروژه های جاری آن مجموعه محترم اقدام مقتضی مبذول گردد. ۱۳۹۷/۰۹/۲۹

طاهر شهنی
رئیس بازارهای

رئیس شرکت الکترو موتور منطقه ویژه شیراز

منطقه ویژه اقتصادی شیراز

به نام خدا

شماره: ۰۰۰۰۰۰
تاریخ: ۱۳۹۷/۰۹/۲۹

با سلام

احتراماً به استحضار می رساند با عنایت به تأکیدات قانونی مبنی بر حمایت از صنایع و تولیدات داخلی - شرکت الکتروموتور منطقه ویژه شیراز (وم پارس) به عنوان یکی از واحدهای صنعتی موفق در حوزه تولید انواع الکتروموتورهای صنعتی سه فاز در منطقه ویژه اقتصادی شیراز به حضورتان معرفی می گردد. شایان ذکر است که این واحد نزدیک به ۱۲ سال است که به عنوان تولید کننده داخلی در این منطقه مشغول به فعالیت بوده و با انتقال دانش فنی و تکنولوژی از شرکت VEM آلمان موفق به تأمین نیاز صنایع مختلف کشور در خصوص تست انواع ماشین های الکتریکی بوده است. لذا خواهشمند است با توجه به پتانسیل های موجود در این مجموعه - زمینه های همکاری لازم در پروژه های جاری را فراهم سازید.

با احترام - طاهر شهنی
مدیر عامل منطقه ویژه اقتصادی شیراز

رئیس شرکت الکتروموتور منطقه ویژه شیراز

دفتر مرکزی: خوارزمی ارجیهولت - منطقهان برج الکترولند - طبقه ۲ - تلفن: ۰۲۱-۲۲۲۲۲۲۲۲ - فکس: ۰۲۱-۲۲۲۲۲۲۲۲
دفتر نمایندگی: بلوار خواجه فارس - کلاهدوز ۷ جنبه هیروکام سیمان ترکیسی - تلفن: ۰۲۱-۲۲۲۲۲۲۲۲ - فکس: ۰۲۱-۲۲۲۲۲۲۲۲
E-mail: soez@seec.ir Website: www.seec.ir



ELECTRIC DRIVES
FOR EVERY DEMAND

VEMParS Motors Co. References

www.vempars.com

www.vem-group.com



VEMPars motor Co.

Main Sales References in Iran



VEM Sachsenwerk GmbH		Dresden		VEM		QR Code	
Made in Germany							
3ph Mot.	DIN EN 60034-1	Typ	DTKYY 1166-4WS				
		Nr.	2384493 / 2021				
	$\Delta \pm 10\%$	11000 V		$\pm 3\%$	50 Hz		
		2127 A					
		40000 kW		-5 / +45 °C			
	cos ϕ	1.0		VUW			
		1500 rpm	IP 55	IC 81 W7			
Exc 358 V	100.0 A				64350 kg		
Water 2x50 m ³ /h	max. 38 °C						
					Th.cl. 155(F) used 130(B)		

IRAN-Asalooye- Damavan Energy utility

Power: 40000 KW speed: 1500 RPM

Year: 2021



VEMPars motor Co.

Main Sales References in Iran



IRAN-Asalooye- Damavan Energy utility

Power: 19500 KW speed: 1500 RPM

Year: 2021



VEMPars motor Co.

Main Sales References in Iran



IRAN-Asalooye- Rayan Polymer

Power: 16030 KW speed: 1500 RPM

Year: 2020



VEMPars motor Co.

Main Sales References in Iran



IRAN-Asalooye- Rayan Polymer

Power: 30450 KW speed: 1000 RPM

Year: 2020



VEMPars motor Co.

Main Sales References in Iran



IRAN-Laleh petrochemical co

Power: 22400 KW speed: 200 RPM

Year: 2003



VEMPars motor Co.

Main Sales References in Iran



IRAN-Ilam refinery Co

Power: 8000 KW speed:900-1800 RPM

Year: 2006



VEMPars motor Co.

Main Sales References in Iran



IRAN-Amirkabir petrochemical co

Power: 22500 KW speed:200 RPM

Year: 2007

ordered by: **SIEMENS**



VEM Pars motor Co.

Main Sales References in Iran

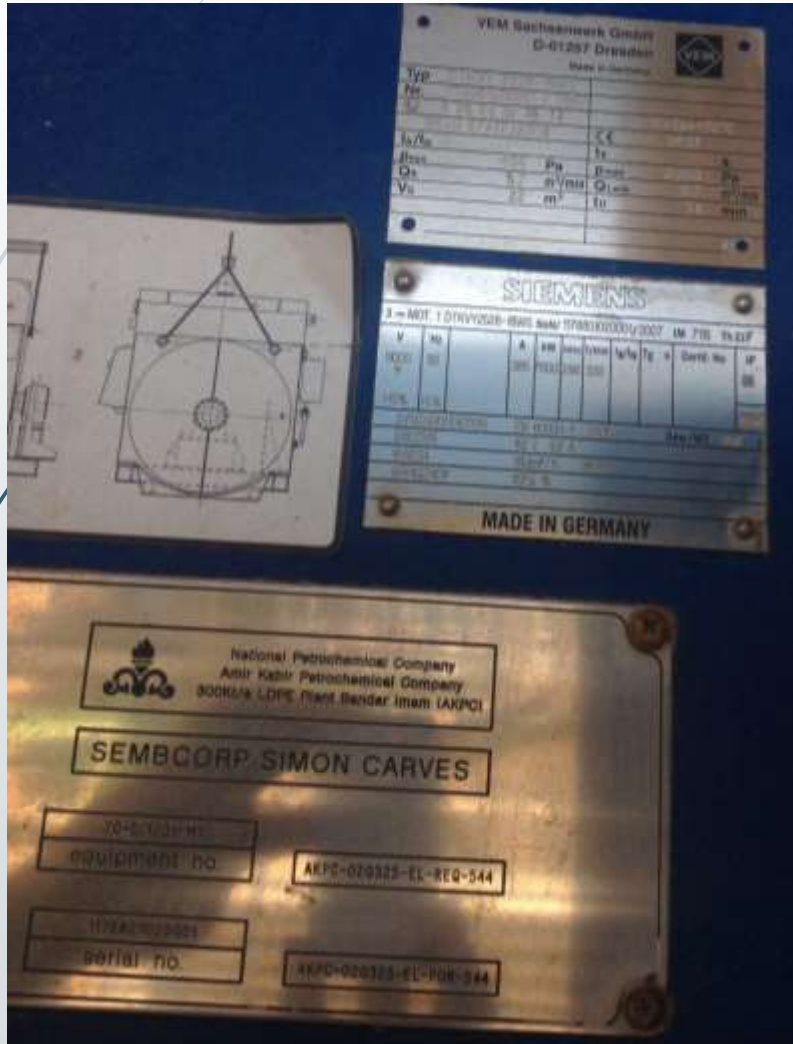

IRAN-Amirkabir petrochemical co

Power: 7000 KW speed:350 RPM

Year: 2007

ordered by: **SIEMENS**



VEM Pars motor Co.

Main Sales References in Iran



IRAN-Mahabad petrochemical Co

Power: 3300 KW- EXp speed:1500 RPM

Year: 2013



VEMPars motor Co.

Main Sales References in Iran



IRAN-Darab cement factory

Power: 3125 KW speed: 1000 RPM

Year: 2002

21-66

Main Sales References in Iran



VEM Pars motor Co.



IRAN-Darab cement factory

Power: 3500 KW speed: 1000 RPM

Year: 2002

22-66

Main Sales References in Iran



VEMPars motor Co.



IRAN-Darab cement factory

Power: 4200 KW speed: 500 RPM

Year: 2002

24-66

Main Sales References in Iran



VEM Pars motor Co.



IRAN-Bookan cement factory

Power: 2200 KW speed:1000 RPM

Year: 2007

25-66

Main Sales References in Iran



VEM Pars motor Co.



IRAN-Bookan cement factory

Power: 2200 KW speed:1000 RPM

Year: 2007

26-66

Main Sales References in Iran



VEMPars motor Co.



IRAN-Bookan cement factory

Power: 2000 KW speed:1000 RPM

Year: 2007

27-66

Main Sales References in Iran



VEMPars motor Co.



IRAN-Bookan cement factory

Power: 1300 KW speed:1000 RPM

Year: 2007

28-66

Main Sales References in Iran



VEMPars motor Co.



IRAN-Kordestan cement factory

Power: 2000 KW speed:1000 RPM

Year: 2013

29-66

Main Sales References in Iran



VEMPars motor Co.



IRAN-Mahabad petrochemical Co

Power: 12000 KW speed:1000 RPM

Year: 2013

Main Sales References in Iran



VEMPars motor Co.



IRAN-Mahabad petrochemical Co

Power: 4600 KW- Exp speed:1500 RPM

Year: 2013



ELECTRIC DRIVES
FOR EVERY DEMAND

VEMPars Motors Co. Installation & Services

www.vempars.com

www.vem-group.com

Service and After sales service



VEMParS motor Co.



A vertical flowchart on the left side of the service advertisement, showing four steps: 'UNPLUGGED', 'PLUGGED', 'UNPLUGGED', and 'UNPLUGGED', each with a corresponding icon and a small image of a technician.

- installation & start up
- inspection
- insite visiting & repairing
- spareparts
- Test and maintenance
- providing standard Test certificate

Three small images illustrating the services: a technician working on a generator, a large industrial motor, and a technician working on a drive unit.

Generator *Motor* *Drive*

A detailed image of a VEM industrial motor, showing its cylindrical body, cooling fins, and mounting feet.

32-66

Main service & after sales service References in Iran



VEMPars motor Co.

BAC motor commissioning and adjustment in Damavan Energy Utility -2021
MV asynchronous - 19000KW- 1500 RPM

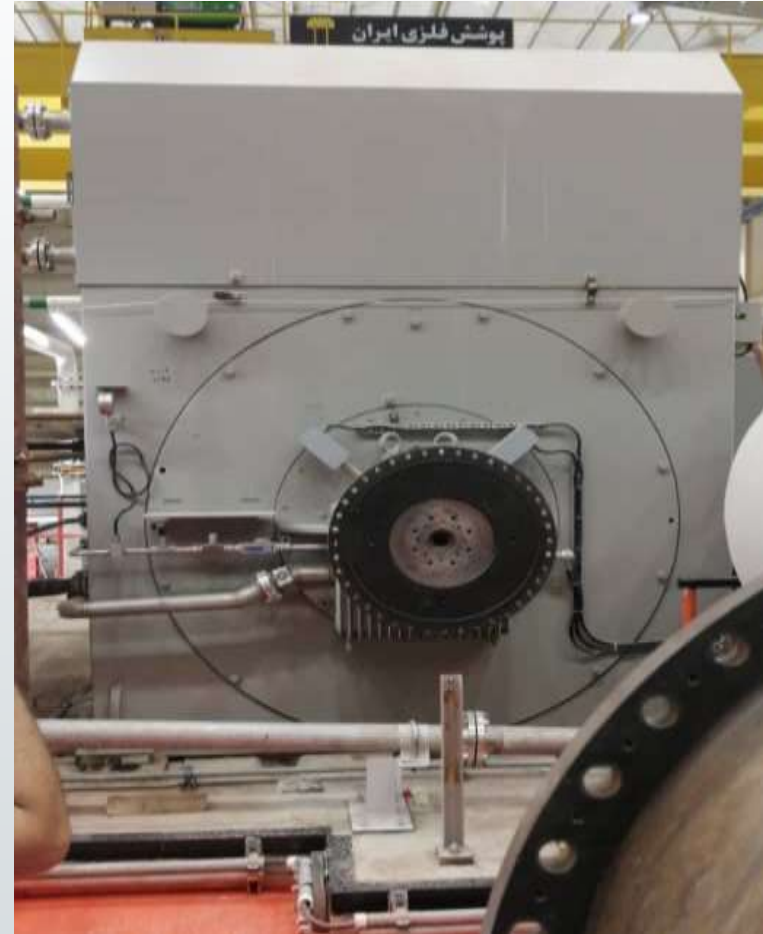

32-66

Main service & after sales service References in Iran



VEMPars motor Co.

MAC motor commissioning and adjustment in Rayan Polymer -2023
MV synchronous - 30450KW- 1000 RPM



Bemessungsdaten / rated data			
3ph Mot.	Typ DTKVY 1158-6WS		
DIN EN 60034-1	Nr. 2383069 / 2020		
±10 %	11000 V	±3 %	50 Hz
	1620 A		
	30450 kW		-5/+55 °C
	cos φ 1.00		\bar{v}_{N}
	1000 rpm	IP 55	IC 81 W7
Exc 68.0 V	787.0 A		57400 kg
Water 2x 40.0 m ³ /h max. 38 °C			
Th.cl. 155 (F) used 130 (B)			



VEMPars motor Co.

MMTE – GoleGohar MV motors installation & free run operation -2023

MV motors - 2300KW- 3600KW- 11000V



32-66

Main service & after sales service References in Iran

PAKCHOOB Co.- pony and main motors bearing and noise check -2023
315KW and 5500KW



VEM Pars motor Co.

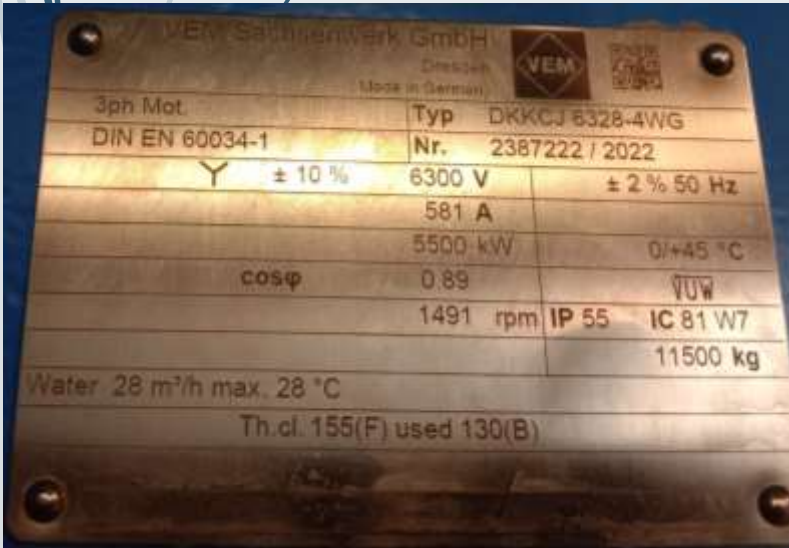

32-66

Main service & after sales service References in Iran



VEMPars motor Co.

MMTE – MV motor vibration test, bearing check and free run operation -2023

MV motors - 4100KW- 11000V



32-66

Main service & after sales service References in Iran

Petropedam SIEMENS motors installation and free run operation -2023
MV motors - 450KW, 560KW



VEMPars motor Co.



32-66

Main service & after sales service References in Iran

ZZIII Khuzestan Steel Co. commissioning, connection checks, RTDs Check -2023

MV motors - 3100KW, 4200KW



VEM Pars motor Co.

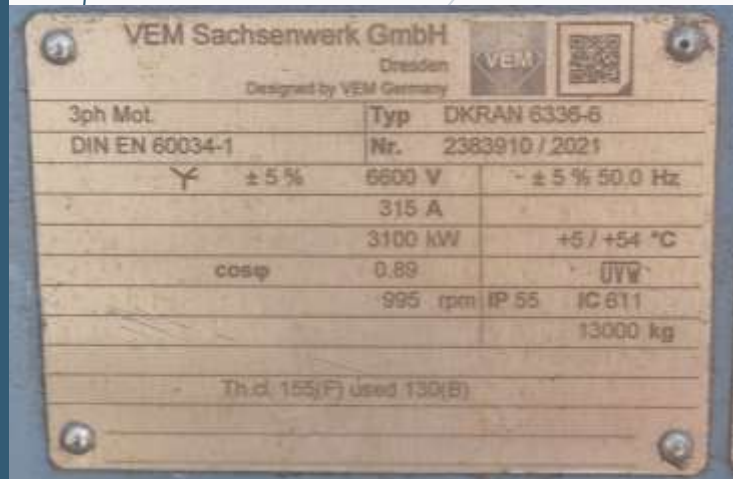

32-66

Main service & after sales service References in Iran

MMTE – GEG main air blower and ejector stack fan motors commissioning and free run operation – 2023



VEMPars motor Co.

VEM Sachsenwerk GmbH			
Dresden		Made in Germany	
3ph Mot.	Typ	DKRES 7140-6WG	
DIN EN 60034-1	Nr.	2386997 / 2023	
$\pm 5\%$	11000 V	$-5/+3\%$ 50 Hz	
	224 A	3650 kW	
		$-15/+42$ °C	
cos ϕ	0.89	VUV	
	993 rpm	IP 55	IC 611
		16850 kg	
Th.cl. 155(F) used 130(B)			
Altitude 1720 m a.s.l.			

VEM Sachsenwerk GmbH			
Dresden		Made in Germany	
3ph Mot.	Typ	DKRES 7136-4WG	
DIN EN 60034-1	Nr.	2386996 / 2023	
$\pm 5\%$	11000 V	$-5/+3\%$ 50 Hz	
	291 A	4900 kW	
		$-15/+42$ °C	
cos ϕ	0.91	VUV	
	1495 rpm	IP 55	IC 611
		17400 kg	
Th.cl. 155(F) used 130(B)			
Altitude 1700 m a.s.l.			



32-66

Main Service References in Iran

Inspection of two VEM main motors in Oxin steel complex- 2016
MV synchronous- 8500 KW- 50 RPM



VEMPars motor Co.



Main Service References in Iran

Damper units and sensors installation in GEG complex- 2017

VEM transformers

GQ001-TA01/ GQ001-TA02/ GQ011-TA01/ GQ041-TA01/ GQ051-TA01



VEMPars motor Co.

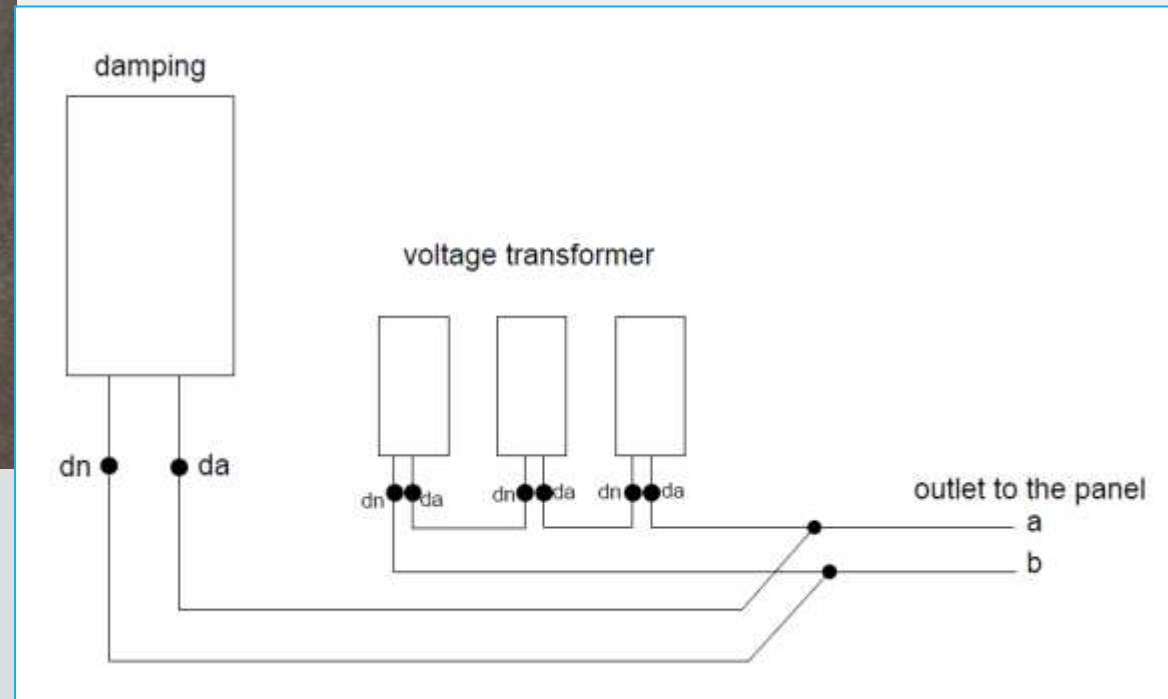

36-66

Main Service References in Iran



VEMPars motor Co.

Damper units and sensors installation in GEG complex- 2017

VEM transformers

GQ001-TA01/ GQ001-TA02/ GQ011-TA01/ GQ041-TA01/ GQ051-TA01



39-66

Main Service References in Iran



VEMPars motor Co.

Butia Steel Co. Supervision- HPGR unit- 2018
1.29 MW LV induction motors & control units



41-66

Winding and repair



VEM Pars motor Co.



42-66

Winding and repair



VEM Pars motor Co.



42-66

Winding and repair



VEMPars motor Co.



42-66

Winding and repair



VEMPars motor Co.

42-66

Winding and repair



VEMPars motor Co.



42-66

Winding and repair



VEM Pars motor Co.



42-66

Winding and repair



VEMPars motor Co.





ELECTRIC DRIVES
FOR EVERY DEMAND

VEMParS Motors Co. Certificates

www.vempars.com

www.vem-group.com

Authorization Letters

43-66



ELECTRIC DRIVES
FOR EVERY DEMAND

DRESDEN
WERNIGERODE
ZWICKAU
MOST
PESTANY



VEMPars motor Co.

VEM Sachsenwerk GmbH - Pirnaer Landstraße 176 - 01257 Dresden

TO WHOM IT MAY CONCERN

AUTHORISATION LETTER

VEM Sachsenwerk GmbH is an international active, independent, German supplier of motors, generators and drive systems up to a power range of 60 MW.

With more than 120 year tradition we rank to the leading manufacturers of high efficient universal and special machines.

We want to strengthen our presence in world market and to continually enlarge our business in the field of special system engineered drives. Therefore, a customer-oriented continuous acquisition is required.

In consequence, we also have concluded a co-operation-agreement with

Electric Motors of Shiraz Special Economic Zone Co.
VEM Pars
Shiraz Special Economic Zone 71 59 11 44 15
Shiraz /Iran

to get a closer contact with the market for high and low voltage machines in the territory of Iran.

Herewith we confirm that VEM Pars is authorised to act in our name, to make business contacts, to receive enquiries and further projects information.

This Authorization Letter has validity until 31st of December 2023.

Dresden, 8th of February 2023

Kai Findeisen
Commercial Manager

René Händler
Sales Director HV



VEMPars motor Co.



Ex - Authorization Letters

Ex authorization letters of VEMPars Co. Experts issued by INSEMEX. 2017



VEMPars motor Co.





ELECTRIC DRIVES
FOR EVERY DEMAND

VEMParS Motors Co. Industry References

www.vempars.com

www.vem-group.com

47-66

References by Industry – Steel and Rolling Mills



VEMPars motor Co.



**Khouzestan Steel,
Ahwaz, Iran
Rolling mill auxiliary drive**

400 kW; 690 V; 995 r.p.m.

48-66

References by Industry – Steel and Rolling Mills



VEMPars motor Co.



**Oxin steel
Ahwaz, Iran. Rolling mill**

**8500 KW, 50 RPM
3100 V, 2006**

References by Industry – Steel and Rolling Mills



VEMPars motor Co.



Oxin steel Ahwaz, Iran.

750 KW, 500 RPM

690 V, 2005

References by Industry – Steel and Rolling Mills



VEMPars motor Co.



Oxin steel Ahwaz, Iran.

850 KW, 1000 RPM

690 V, 2005

50-66

References by Industry – Steel and Rolling Mills



VEMPars motor Co.



Butia steel , Kerman, Iran.

1290 KW, 1000 RPM HPGR unit

660 V, 2022

References by Industry – Steel and Rolling Mills



VEMPars motor Co.



PASCO, Shiraz, Iran.

4 pcs of 1650 KW, 750 RPM

seamless project

690 V, 2023

VEM motore GmbH		Th.Kl./Th.at./Cl.th. FCB)	
D 38455 Wernigerode		IP 55 7500 kg	
Made in Germany			
3-Ph.Nr./N*/M.	1022 00081	K87A S00L 8 AH	
V	Hz	cos φ	A
600 Δ	50	0,81	2042
Umrichterbetrieb/Converter feeding/Alim. par convertisseur			min ⁻¹ /r.p.m./ rev/m
403 Δ	33,7	0,80	2087
500 Δ	50,05	0,80	2078
690 Δ	57,5	0,78	1852
690 Δ	65,0	0,84	1715
690 Δ	67,05	0,85	1696
IM 80/1001 S1/S9	IEC/EN 60034-1	Rt: 25...+40°C...1600m	
Fett/Grease/Graisse SHELL Gadus S2 V100 3		VEM 20253169/0001 04/2023	
DE 2X 7.332 B.M.P./UA30/30 g	1000 h		
IE 6392 MCO	20 g		

50-66

References by Industry – Steel and Rolling Mills



VEMPars motor Co.



NICICO, Darezar, Iran.

8 pcs of 360 KW, 1500 RPM

Gearbox application in mine

6600 V, 2022

References by Industry – Water industry & Pumps



VEMPars motor Co.

Item	power (KW)	speed (RPM)	project	quantity (pcs)	year	client	contractor	consultant
1	355	1500	Gavshan	7	2008	Kermanshah Water Authority Co.	Koomar Co.	Mahab Ghods Co.
2	250	1500	Gavshan	4	2009	Kermanshah Water Authority Co.	Tara Co.	Mahab Ghods Co.
3	315	1500	Gavshan	3	2009	Kermanshah Water Authority Co.	Tara Co.	Mahab Ghods Co.
4	11	1500	Gavshan	3	2011	Kermanshah Water Authority Co.	Bistonn Sobh Gharb	Mahab Ghods Co.
5	15	1500	Gavshan	9	2011	Kermanshah Water Authority Co.	Bistonn Sobh Gharb	Mahab Ghods Co.
6	18.5	1500	Gavshan	9	2011	Kermanshah Water Authority Co.	Bistonn Sobh Gharb	Mahab Ghods Co.
7	22	1500	Gavshan	30	2011	Kermanshah Water Authority Co.	Bistonn Sobh Gharb	Mahab Ghods Co.
8	30	1500	Gavshan	33	2011	Kermanshah Water Authority Co.	Bistonn Sobh Gharb	Mahab Ghods Co.
9	37	1500	Gavshan	3	2011	Kermanshah Water Authority Co.	Bistonn Sobh Gharb	Mahab Ghods Co.
10	315	1500	Gavshan	7	2010	Kermanshah Water Authority Co.	Ashayesh Afza	Mahab Ghods Co.
11	110	1500	Gavshan	6	2011	Kermanshah Water Authority Co.	Kasra	Mahab Ghods Co.
12	110	1500	Siyah Zakh	10	2010	Kurdistan Water Authority Co.	Jahad Nasr Co.	Mahab Ghods Co.
13	500	1500	Siyah Zakh	10	2010	Kurdistan Water Authority Co.	Jahad Nasr Co.	Mahab Ghods Co.
14	400	1500	Siyah Zakh	10	2010	Kurdistan Water Authority Co.	Jahad Nasr Co.	Mahab Ghods Co.
15	1300	3000	Ahar	3	2011	*	KSB	*
16	1060	3000	Ahar	1	2011	*	KSB	*
17	355	1500	Ghadir	8	2012	Khozestan water & power Org.	Khozestan water & power Org.	Mahab Ghods Co.
18	315	1500	Shooshtar	8	2015	Khozestan water & power Org.	Khozestan water & power Org.	Dejab Khozetan
19	250	1500	sistan (Hamoons Pump Station)	12	2017	Jahad Agriculture Ministry	Farasan industrial group	Ab o Khak Tehran Co.
20	315	1500	Arsenjan Urban water Pump Station	3	2017	Fars Water Authority Co.	Masir Gostar Jonob	Absar Fars Co.
21	37	1500	Khoda Afarin Project	12	2018	Ardebil Water Authority Co.	Limit Co.	Mahab Ghods Co.
22	45	1500	Khoda Afarin Project	4	2018	Ardebil Water Authority Co.	Limit Co.	Mahab Ghods Co.
23	75	1500	Khoda Afarin Project	4	2018	Ardebil Water Authority Co.	Limit Co.	Mahab Ghods Co.
24	90	1500	Khoda Afarin Project	5	2018	Ardebil Water Authority Co.	Limit Co.	Mahab Ghods Co.
25	110	1500	Khoda Afarin Project	8	2018	Ardebil Water Authority Co.	Limit Co.	Mahab Ghods Co.
26	132	1500	Khoda Afarin Project	8	2018	Ardebil Water Authority Co.	Limit Co.	Mahab Ghods Co.
27	200	1500	Khoda Afarin Project	10	2018	Ardebil Water Authority Co.	Limit Co.	Mahab Ghods Co.

52-66

References by Industry – Water industry & Pumps



VEMPars motor Co.



**VEM motors- Ghadir water transfer Project
8 pcs of 355 KW, 1500 RPM - 2012**



**VEM motors- Gavshan water transfer project
110 KW to 355 KW, 1500 RPM, 2009**



VEMPars motor Co.



**VEM motors- Abadan Oil refinery- chemical pump station
7.5 KW . 3000 RPM / 15KW. 3000 RPM, 2017**

References by Industry – Water industry & Pumps



VEMPars motor Co.



**VEM motors- Arsenjan Pump Station – Sivand Dam
3pcs of 315 KW 1500 RPM, 2017**

References by Industry – Water industry & Pumps



VEMPars motor Co.



**VEM motors- Kala Pump
6 pcs of 560 KW- 1500 RPM- 6000 V, 2017**

56-66

References by Industry – Water industry & Pumps



**Asalooyeh power plant for PUMPIRAN
2 pcs of 850 KW- 1500 RPM- 6600 V, 2021 vertical flange mounted**

References by Industry – Water industry & Pumps



VEMPars motor Co.

VEM GmbH, Dresden,				
Made by VEM				
3ph Mot.	Type DKCAJ 5632-6			
IEC 60034-1	No. 8230186-4 / 2023			
Y	6000	V	50 Hz	
	147.5	A		
S1	1300 kW		-7 / +48 °C	
cos φ	0.88		CCW	
	995 rpm	IP 55	IC 411	
			10550 kg	
Th.cl. 155(F) used 130(B)				



PETCO

10 pcs of 1300 KW- 1000 RPM- 6000 V, 2023

References by Industry – Smoke Motors



VEMPars motor Co.

- **Tehran Metro – line 3**

163 pcs of smoke motor

(37 kw, 45 kw, 55 kw , 75 kw , 90 kw, 110 kw, 132 kw) , FV1 (250 ° C at 1 hour)

- **Tehran Metro – line 4**

41 pcs of smoke motor

(37 kw, 55 kw , 75 kw , 90 kw, 110 kw, 132 kw) , FV1 (250 ° C at 1 hour)

References by Industry – Smoke Motors



VEMPars motor Co.

- **Tehran Metro – line 7**

10 pcs of smoke motor

(90 kw, 110 kw , 160kw) , FV1 (250 ° C at 1 hour)

- **Shiraz Metro – line 1- part 1 & 2**

111 pcs of smoke motor

(110 kw, 45 kw, 80 kw , 75 kw , 90 kw, 110 kw, 28 kw, 140 kw) ,

FV1 (250 ° C at 1 hour)

References by Industry – Smoke Motors



VEMPars motor Co.

Tehran Metro- line 6

22 pcs of smoke motor (132kw, 160kw, 200 kw, 250kw , 315 kw),

FV1. IE2 (250 ° C at 1 hour)

Tehran Shomal freeway- part1 & 2

200 pcs of smoke motors (7.5kw to 250 kw), FV2 (250 ° C at 2 hour)

Esfahan Metro- line1



ELECTRIC DRIVES
FOR EVERY DEMAND

VEMPars Motors Co. Seminars and Exhibitions

www.vempars.com

www.vem-group.com

60-66

VEM Water Seminar - 2016



VEMPars motor Co.

Ministry of Energy, Abniru Co. - Tehran



61-66

VEM Water Seminar - 2016



VEMPars motor Co.

Ministry of Energy, Abniru Co. - Tehran



Ex Seminar – Shiraz 2017



VEMPars motor Co.



ELECTRIC DRIVES
 FOR EVERY DEMAND



سمینار آموزشی

شرکت الکترو موتور منطقه ویژه شیراز برگزار می نماید:

کدامیک از انواع موتورهای ضد انفجار برای پروژه من مناسب است؟
 آموزش انتخاب صحیح موتورهای ضد انفجار توسط کارشناسان ارشد اداره استاندارد آلمان
 جلسه پرسش و پاسخ با حضور کارشناسان و طراحان فنی داخلی و خارجی صنعت نفت، گاز، پالایش و
 پتروشیمی کشور
 زمان: آبانماه سال ۱۳۹۵
 مکان: سالن بین المللی مجتمع آموزشی و فرهنگی احسان
 با ما تماس بگیرید: ۰۷۱۳ ۷۷۱۳۵۲۵ - ۰۲۱ ۸۸۸۷۰۷۳۲

Which Ex motors are suitable for my project?
 Ex e..? Ex nA..? Ex p..? Ex d..? Ex t..? Ex m..? Ex q..?
 Zone 0,1,2...? Or Zone 20,21,22...?
 IIB?... IIC?... T3?... T4..?
 Date: November 2016
 Place: Shiraz – Ehsan Complex.
 info@vempars.com



Marine & Offshore – Kish island 2017



VEMPars motor Co.





ELECTRIC DRIVES
FOR EVERY DEMAND

VEMParS Motors Co. Applicable Documents

www.vempars.com

www.vem-group.com

TECHNICAL DOCUMENTS



- ✓ **Data sheet**
- ✓ **Drawings & dimension**
- ✓ **Test certificate**
- ✓ **Type test**
- ✓ **Curves**
- ✓ **Connection diagram**
- ✓ **Customer needed documents**

COMMERCIAL DOCUMENTS



- ✓ **Certificate of Origin**
- ✓ **Packing List**
- ✓ **Bill of Lading**
- ✓ **Order confirmation**
- ✓ **Invoice**
- ✓ **Formal documents of custom clearance**



VEMPars motor Co.

Some Of Clients/ Customers



66-66

Contact us



VEMPars motor Co.

Shiraz:

SEEZ, VEMPars Co.

Tel: +98 71 37 17 51 56

Fax: +98 71 37 17 51 57

Tehran:

Africa Blvd., Anahita Tower,
Unit 901.

Tel: +98 21 888 70 732

Fax: +98 21 888 70 733



Skype:

VEMPars Company



ELECTRIC DRIVES
FOR EVERY DEMAND

**Some other brands
references except VEM**

www.vempars.com

www.vem-group.com

65-66

PASCO 1250KW slip ring motor & liquid starter SEC brand recycle ball mill - 2021



VEMPars motor Co.



65-66

PASCO 1250KW slip ring motor from SEC brand dry ball mill - 2022



VEMPars motor Co.



65-66

SISCO 2200KW, 6600V, motor from WEG brand 2022



VEMPars motor Co.



AI
honor 8X

65-66

**PETROPEDAM 2pcs of 560KW, 4pcs of 450KW, 11000V
SIEMENS brand
2023**



VEMPars motor Co.



65-66

PETROPEDAM 5 pcs of 840KW, 6600V, motors SIEMENS brand 2022



VEMPars motor Co.

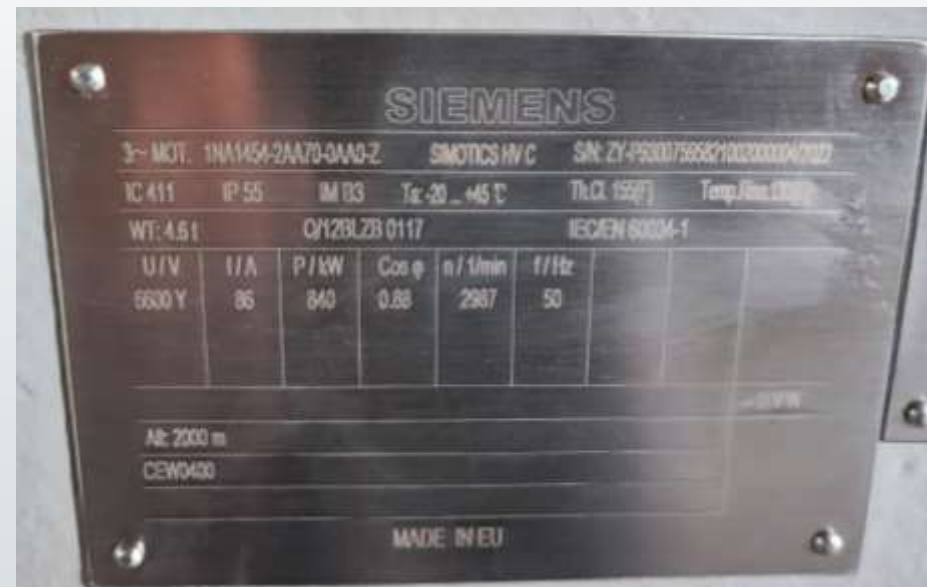

3~ MCT. 1NA1454-2AA70-0AA0-Z SIMOTICS HV C S/N: ZY-493007585821002000004/2022

IC 411 IP 55 IM B3 T_a: -20...+45 °C Th.C. 150[F] Temp./lim. 130[F]

WT: 4.5t QM2BLZB 0117 IEC/EN 60034-1

U/V	I/A	P/kW	cos φ	n / 1/min	f/Hz
6600 Y	86	840	0.88	2967	50

Alt: 2000 m
CEW0400

MADE IN EU